

제어기기 종합카탈로그

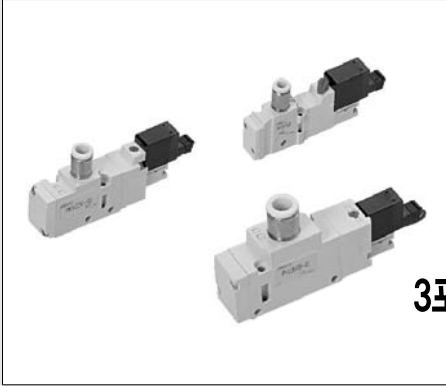

3PORT SOLENOID VALVE 3포트 솔레노이드 밸브 PKV□90 시리즈 INDEX

PKV 190 · 290 · 390 ————— 114
PMKV 190 · 290 · 390 ————— 119

SVR10

SVA20

D-sub
커넥터

PKV

PNV

PV PLV

유체제어
밸브

앵글밸브

PCMP□

PCFA

PCFB

K□F

K□FW

PCJQ

PCJT

PCJQ2

PCJS

PCJK

PCGA

PCGB

PCGD

PGT□

PCGJ

PCG3

PCDA

PCDB

KCSS

⚠ 주의 사용하기 전에 부록(前)-P,54의 「안전상의 주의」를 반드시 읽어 주십시오.

SVR10

SVA20

D-sub
커넥터

PKV

PNV

PV PLV

유체제어
밸브

영급밸브

PCM, PCD

PCFA

PCFB

KDF

KDFW

PCJQ

PCJT

PCJQ2

PCJS

PCJK

PCGA

PCGB

PCGD

PGT□

PCGJ

PCG3

PCDA

PCDB

KCSS

3포트 솔레노이드 밸브

PKV 190 · 290 · 390

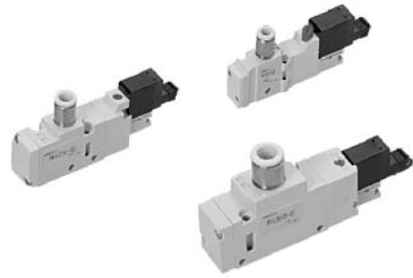

사양

항목	형식	PKV 190, 180	PKV 290, 280	PKV 390, 380
사용유체		압축공기, 불활성 가스		
사용압력	MPa	0.15~0.7		
주위 및 사용유체온도	℃	최고 50		
유효단면적	mm ²	6.0(0.58)	10.5(0.58)	16.0(0.9)
응답시간	ms	≤12	≤15	≤25
최대작동빈도	c/s	5	5	5
급유		불필요		
중량	g	28.2	49.0	74.2

커넥터 주문형식

CA2 - V4 - 6

커넥터 Ass'y

정격전압

리드선 길이

V1 : AC 110
V2 : AC 220
V4 : DC 전압

- : 300mm
6 : 600mm
10 : 1000mm
15 : 1500mm
20 : 2000mm
25 : 2500mm
30 : 3000mm
50 : 5000mm

주문형식

PKV 1 9 0 - 4 E S - C4

시리즈

- 1 : PKV 190 (폭: 10mm)
- 2 : PKV 290 (폭: 15mm)
- 3 : PKV 390 (폭: 18mm)

전환방식

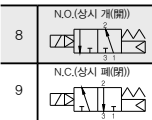

정격전압

- 1 : AC 100V
- 2 : AC 220V
- 3 : DC 12V
- 4 : DV 24V
- 6 : DC 6V
- 9 : 특수전압

결선방식

※ P형 플러그 커넥터 방식에는 AC전압의 제품이 없습니다.

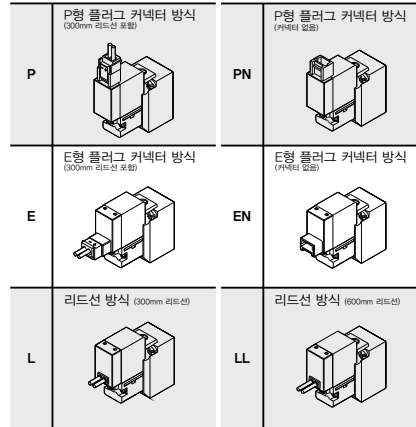

배관접속구경-2(A)

기호	배관접속구경	PKV190	PKV290	PKV390
C4	φ4용 원터치 피팅	○	○	-
C6	φ6용 원터치 피팅	○	○	○
C8	φ8용 원터치 피팅	-	○	○
M5	M5 나사	○	-	-
01	Rc(PT)1/8	-	○	-
02	Rc(PT)1/4	-	-	○

램프, 서지전압 보호회로

무기입 : 표준타입

Z : 유극성램프 = 다이오드 부착(DC)

S : 서지보호회로 부착(DC)

내부구조도 및 주요 부위의 재질

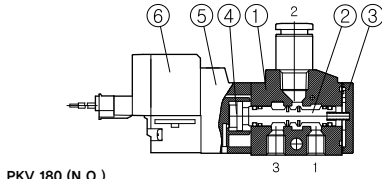

PKV 180 (N.O.)

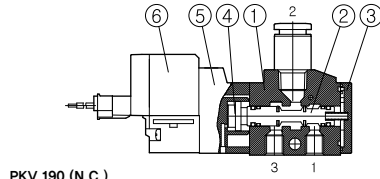
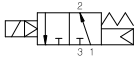

PKV 190 (N.C.)

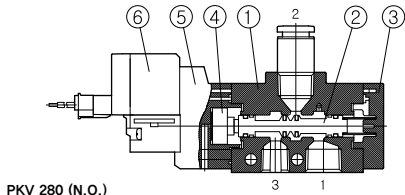
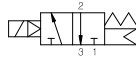

PKV 280 (N.O.)

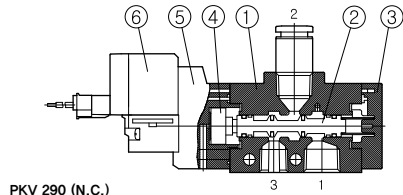
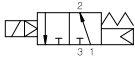

PKV 290 (N.C.)

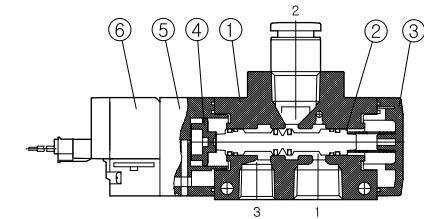
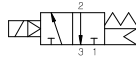

PKV 380 (N.O.)

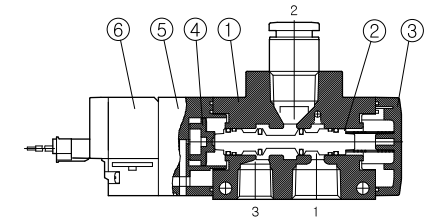
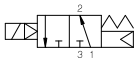

PKV 390 (N.C.)

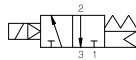

No.	명 칭	재 질
①	본체	ADC-12
②	스풀	알루미늄 · 합성고무(NBR)
③	엔드 커버	플라스틱
④	피스톤	플라스틱
⑤	어댑터	플라스틱
⑥	코일 Ass'y	-

SVR10

SVA20

D-sub
커넥터

PKV

PNV

PV PLV

유체제어
밸브

앵글밸브

PCMP□

PCFA

PCFB

K□F

K□FW

PCJQ

PCJT

PCJQ2

PCJS

PCJK

PCGA

PCGB

PCGD

PGT□

PCGJ

PCG3

PCDA

PCDB

KCSS

SVR10

SVA20

D-sub
커넥터

PKV

PNV

PV PLV

유체제어
밸브

영글밸브

PCM, P□

PCFA

PCFB

K□F

K□FW

PCJQ

PCJT

PCJQ2

PCJS

PCJK

PCGA

PCGB

PCGD

PGT□

PCGJ

PCG3

PCDA

PCDB

KCSS

치수도 (mm)

직접 배관형

E형 플러그 커넥터 방식 PKV 190 - 4E - □

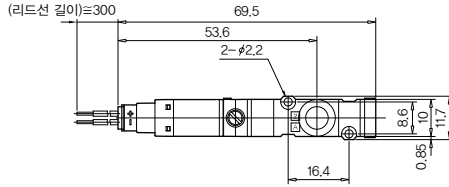

A(2)포트 = C4, C6, M5
 (C4 : φ4 원타치 피팅)
 (C6 : φ6 원타치 피팅)
 (M5 : M5 나사)

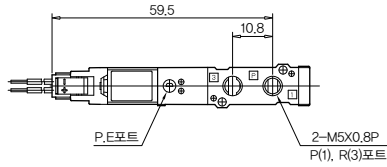
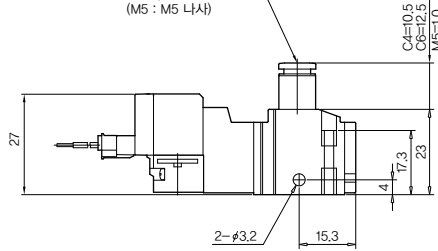
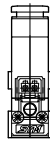

리드선 방식 (L) PKV 190 - 4L - □

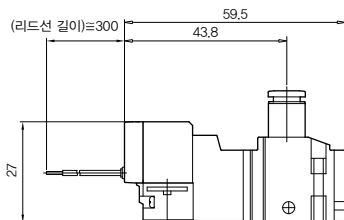

P형 플러그 커넥터 방식 PKV 190 - 4P - □

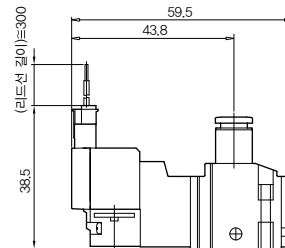

치수도 (mm)

직접 배관형

E형 플러그 커넥터 방식 PKV 290 - 4E - □

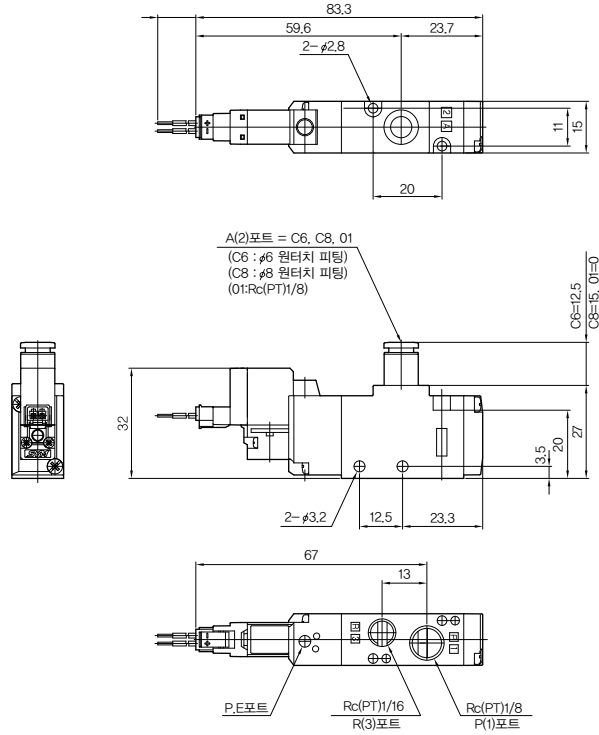

리드선 방식 (L) PKV 290 - 4L - □

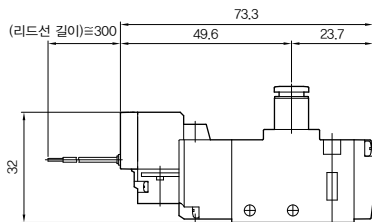

P형 플러그 커넥터 방식 PKV 290 - 4P - □

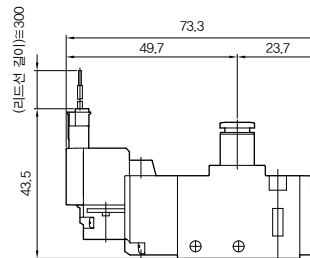

SVR10

SVA20

D-sub
커넥터

PKV

PNV

PV PLV

유체제어
밸브

앵글밸브

PCMP□

PCFA

PCFB

K□F

K□FW

PCJQ

PCJT

PCJQ2

PCJS

PCJK

PCGA

PCGB

PCGD

PGT□

PCGJ

PCG3

PCDA

PCDB

KCSS

SVR10

SVA20

D-sub
커넥터

PKV

PNV

PV PLV

유체제어
밸브

영글밸브

PCM, P□

PCFA

PCFB

K□F

K□FW

PCJQ

PCJT

PCJQ2

PCJS

PCJK

PCGA

PCGB

PCGD

PGT□

PCGJ

PCG3

PCDA

PCDB

KCSS

치수도 (mm)

직접 배관형

E형 플러그 커넥터 방식 PKV 390 - 4E - □

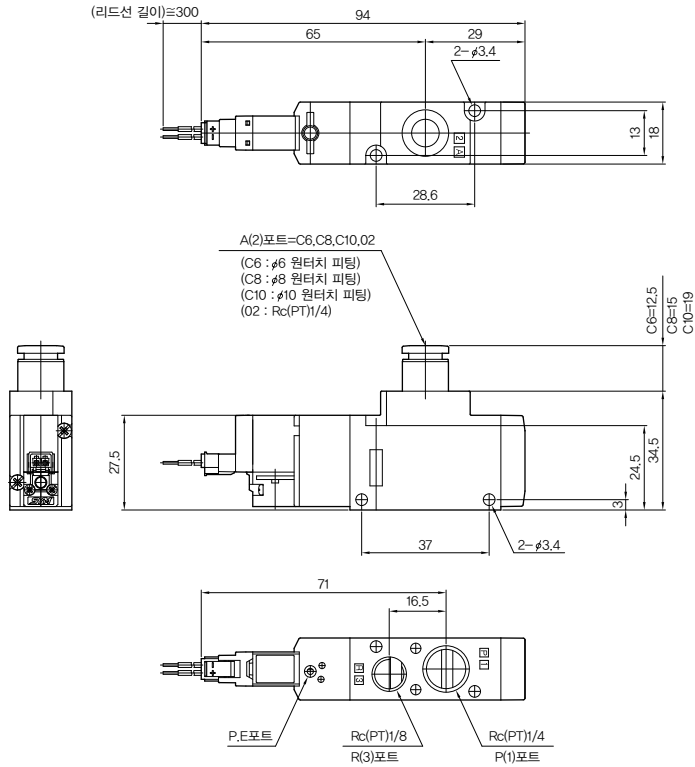

리드선 방식 (L) PKV 390 - 4L - □

P형 플러그 커넥터 방식 PKV 390 - 4P - □

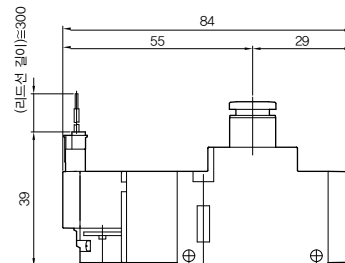
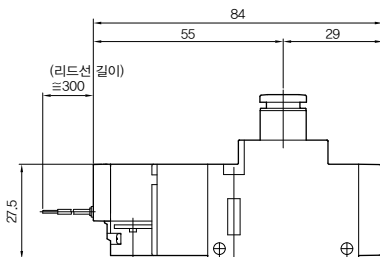

매니폴드 블록

PMKV 190 · 290 · 390

주문형식

PMKV 1 9 0 - 05 DS - D

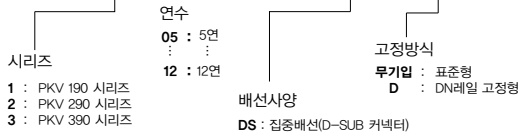

밸브 주문형식

PKV 1 9 0 - 4 E - C4

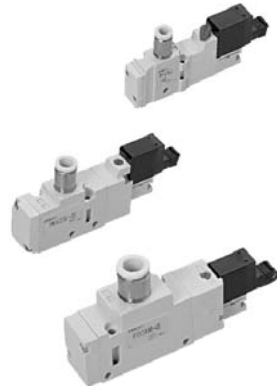
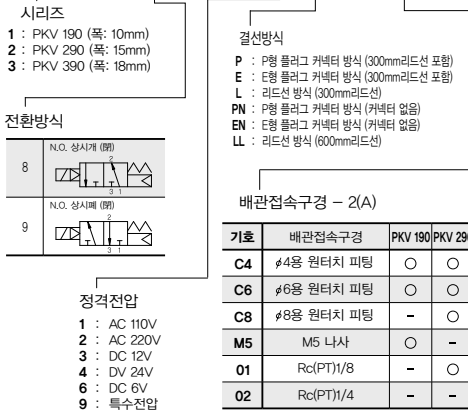

기호	배관접속구경	PKV 190	PKV 290	PKV 390
C4	φ4용 원터치 피팅	○	○	-
C6	φ6용 원터치 피팅	○	○	○
C8	φ8용 원터치 피팅	-	○	○
M5	M5 나사	○	-	-
01	Rc(PT)1/8	-	○	-
02	Rc(PT)1/4	-	-	○

SVR10

SVA20

D-sub
커넥터

PKV

PNV

PV PLV

유체제어
밸브

앵글밸브

PCMP□

PCFA

PCFB

K□F

K□FW

PCJQ

PCJT

PCJQ2

PCJS

PCJK

PCGA

PCGB

PCGD

PGT□

PCGJ

PCG3

PCDA

PCDB

KCSS

SVR10

SVA20

D-sub
커넥터

PKV

PNV

PV PLV

유체제어
밸브

영광밸브

PCM, P□

PCFA

PCFB

K□F

K□FW

PCJQ

PCJT

PCJQ2

PCJS

PCJK

PCGA

PCGB

PCGD

PGT□

PCGJ

PCG3

PCDA

PCDB

KCSS

치수도 (mm)

PMKV190 - □ - D

E형 플러그 커넥터 방식

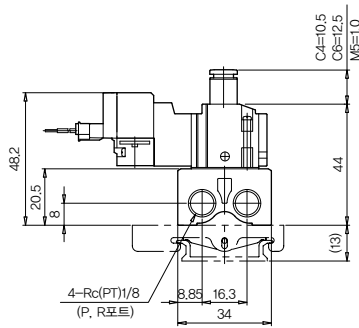
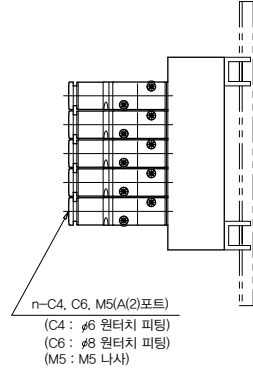
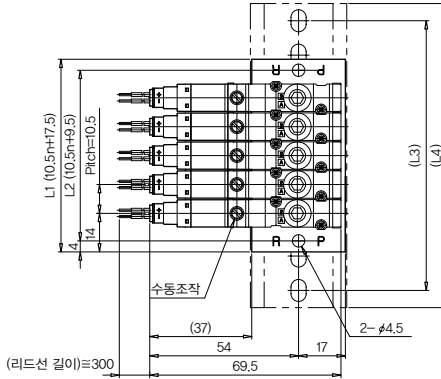

리드선 방식 (L)

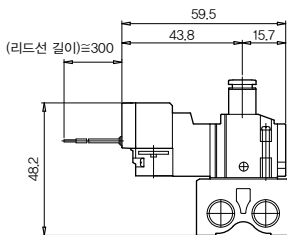

P형 플러그 커넥터 방식

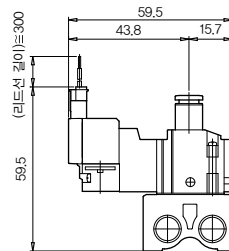

L	n	2	3	4	5	6	7	8	9	10	11	12	13	14	15	16	17	18	19	20
L1		38.5	49	59.5	70	80.5	91	101.5	112	122.5	133	143.5	154	164.5	175	185.5	196	206.5	217	227.5
L2		30.5	41	51.5	62	72.5	83	93.5	104	114.5	125	135.5	146	156.5	167	177.5	188	198.5	209	219.5
L3		62.5	75	87.5	100	100	112.5	125	137.5	150	162.5	175	175	187.5	200	212.5	225	227.5	237.5	250
L4		73	85.5	98	110.5	110.5	123	135.5	148	160.5	173	185.5	185.5	198	198	223	235.5	248	248	260.5

치수도 (mm)

PMKV190 - □DS - D

E형 플러그 커넥터 방식

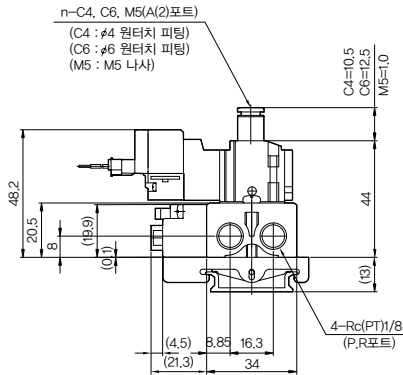
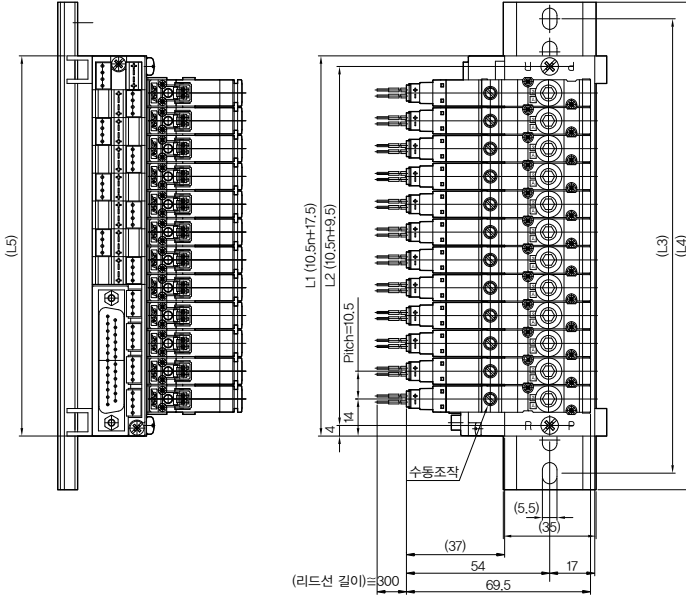

L	n	5	6	7	8	9	10	11	12
L1		70	80.5	91	101.5	112	122.5	133	143.5
L2		62	72.5	83	93.5	104	114.5	125	135.5
L3		100	100	112.5	125	137.5	150	162.5	175
L4		110.5	110.5	123	135.5	148	160.5	173	185.5
L5		70	80.5	91	101.5	112	122.5	133	143.5

SVR10
SVA20
D-sub 커넥터
PKV
PNV
PV PLV
유체제어 밸브
앵글밸브
PCMP□
PCFA
PCFB
K□F
K□FW
PCJQ
PCJT
PCJQ2
PCJS
PCJK
PCGA
PCGB
PCGD
PGT□
PCGJ
PCG3
PCDA
PCDB
KCSS

SVR10

SVA20

D-sub
커넥터

PKV

PNV

PV PLV

유체제어
밸브

영광밸브

PCM, P□

PCFA

PCFB

KDF

KDFW

PCJQ

PCJT

PCJQ2

PCJS

PCJK

PCGA

PCGB

PCGD

PGT□

PCGJ

PCG3

PCDA

PCDB

KCSS

치수도 (mm)

PMKV290 - □ - D

E형 플러그 커넥터 방식

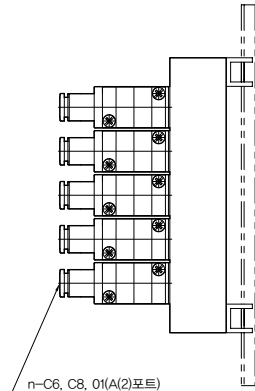
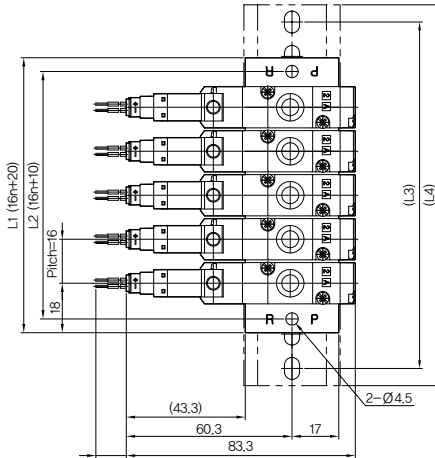

(C4 : $\phi 6$ 원터치 피팅)
(C6 : $\phi 8$ 원터치 피팅)
(O1 : Rc(PT)1/8)

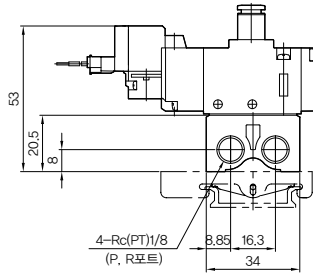

리드선 방식 (L)

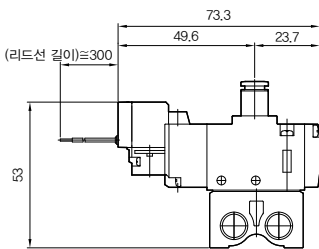

P형 플러그 커넥터 방식

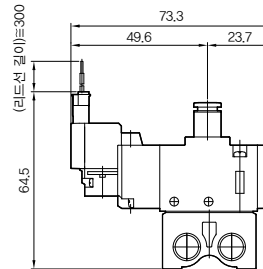

L	n	2	3	4	5	6	7	8	9	10	11	12	13	14	15	16	17	18	19	20
L1	L1	52	68	84	100	116	132	148	164	180	196	212	228	244	260	276	292	308	324	340
	L2	42	58	74	90	106	122	138	154	170	186	202	218	234	250	266	282	298	314	330
L3	L3	75	87.5	112.5	125	137.5	162.5	175	187.5	200	225	237.5	250	275	287.5	300	312.5	337.5	350	362.5
	L4	85.5	98	123	135.5	173	173	185.5	198	210.5	235.5	248	260.5	285.5	298	310.5	323	348	360.5	373

치수도 (mm)

PMKV290 - □DS - D

E형 플러그 커넥터 방식

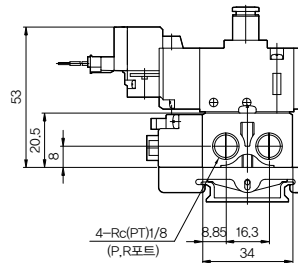
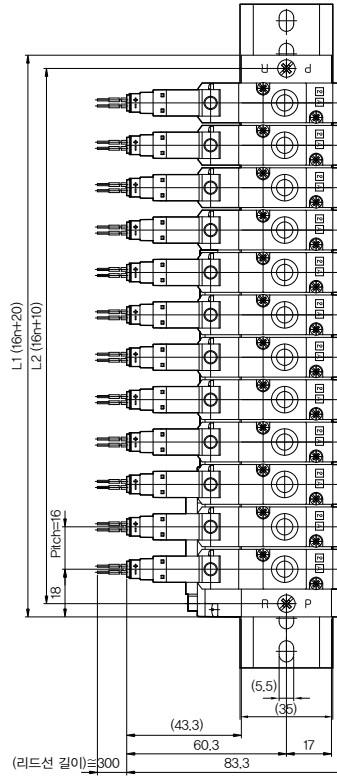
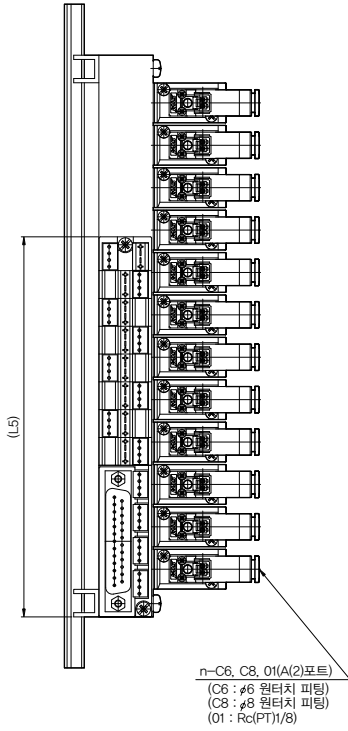

n	5	6	7	8	9	10	11	12
L1	100	116	132	148	164	180	196	212
L2	90	106	122	138	154	170	186	202
L3	125	137,5	162,5	175	187,5	200	225	237,5
L4	135,5	148	173	185,5	198	210,5	235,5	248
L5	100	116	132	148	164	180	196	212

SVR10
SVA20
D-sub 커넥터
PKV
PNV
PV PLV
유체제어 밸브
앵글밸브
PCMP□
PCFA
PCFB
K□F
K□FW
PCJQ
PCJT
PCJQ2
PCJS
PCJK
PCGA
PCGB
PCGD
PGT□
PCGJ
PCG3
PCDA
PCDB
KCSS

SVR10

SVA20

D-sub
커넥터

PKV

PNV

PV PLV

유체제어
밸브

영광밸브

PCM,PD

PCFA

PCFB

KDF

KDFW

PCJQ

PCJT

PCJQ2

PCJS

PCJK

PCGA

PCGB

PCGD

PGT□

PCGJ

PCG3

PCDA

PCDB

KCSS

치수도 (mm)

PMKV390 - □ - D

E형 플러그 커넥터 방식

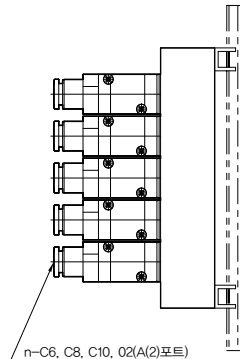
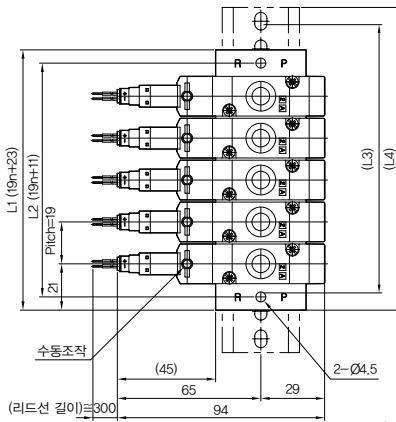

n-C6, C8, C10, 02(A(2)포트)
 (C6 : φ6 원터치 피팅)
 (C8 : φ8 원터치 피팅)
 (C10 : φ10 원터치 피팅)
 (02 : Rc(PT)1/4)

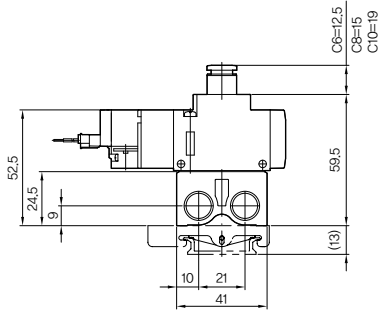

리드선 방식 (L)

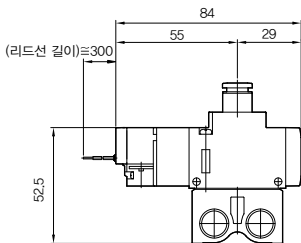

P형 플러그 커넥터 방식

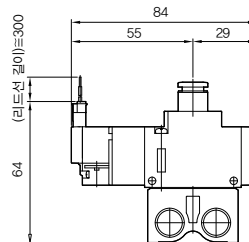

L	n	2	3	4	5	6	7	8	9	10	11	12	13	14	15	16	17	18	19	20
L1	61	80	99	118	137	156	175	194	213	232	251	270	289	308	327	346	365	384	403	
L2	49	68	87	106	125	144	163	182	201	220	237	256	277	296	315	334	353	372	391	
L3	87.5	100	125.5	137.5	162.5	187.5	200	225	237.5	262.5	275	300	312.5	337.5	350	375	387.5	412.5	425	
L4	98	110.5	135.5	148	173	198	210.5	235.5	248	273	285.5	310.5	323	348	360.5	385.5	398	423	435.5	

치수도 (mm)

PMKV390 - □DS - D

E형 플러그 커넥터 방식

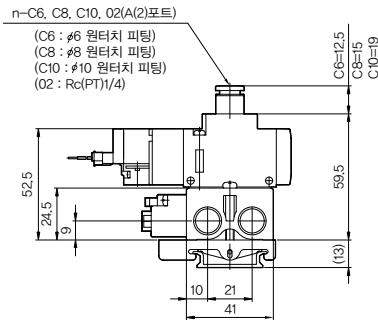
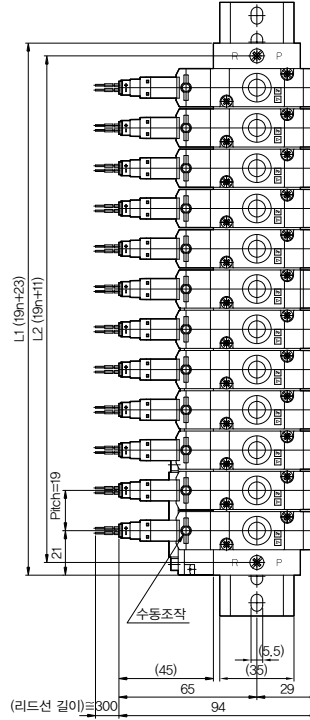
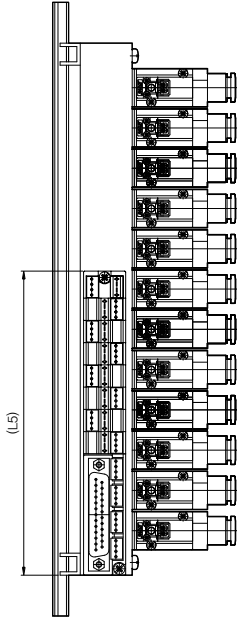

L \ n	5	6	7	8	9	10	11	12
L1	118	137	156	175	194	213	232	251
L2	106	125	144	163	182	201	220	237
L3	137.5	162.5	187.5	200	225	237.5	262.5	275
L4	148	173	198	210.5	235.5	248	273	285.5
L5	118	137	156	175	194	213	232	251

SVR10
SVA20
D-sub 커넥터
PKV
PNV
PV PLV
유체제어 밸브
앵글밸브
PCMP□
PCFA
PCFB
K□F
K□FW
PCJQ
PCJT
PCJQ2
PCJS
PCJK
PCGA
PCGB
PCGD
PGT□
PCGJ
PCG3
PCDA
PCDB
KCSS

SVR10

SVA20

D-sub
커넥터

PKV

PNV

PV PLV

유체제어
밸브

영급밸브

PCM, P□

PCFA

PCFB

K□F

K□FW

PCJQ

PCJT

PCJQ2

PCJS

PCJK

PCGA

PCGB

PCGD

PGT□

PCGJ

PCG3

PCDA

PCDB

KCSS

커넥터 내부 회로도

D-SUB 커넥터

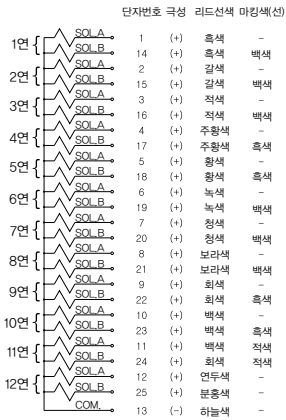

내부 배선은 커넥터의 각 연수마다 SOL.A, SOL.B로 결선되어 있습니다.

케이블 어셈블리

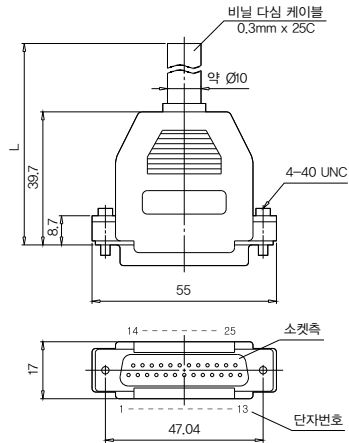

케이블 길이(L)	어셈블리	비고
1.5m	DSC25-1500	
3m	DSC25-3000	케이블 25심 x 24AWG
5m	DSC25-5000	